

HAZ METAL
FIXING SYSTEMS

HA01

HA L ANCHOR FIXING SYSTEM

Concept Drawings

Series: HAZCD-HA01-ST

Direct Fixing System For Rain Screen
Stone Cladding System for Installation at
Horizontal Joints

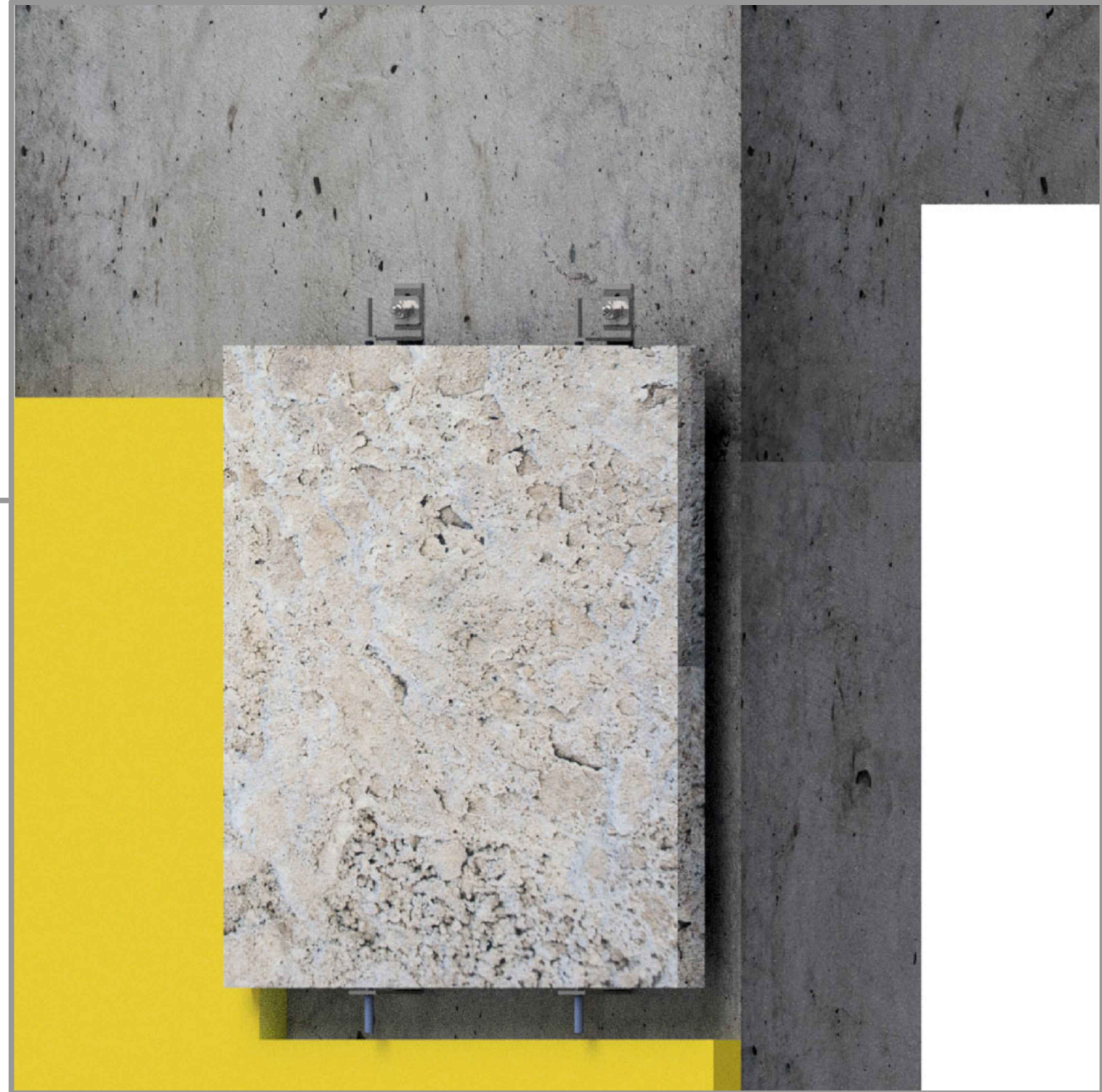

HA01

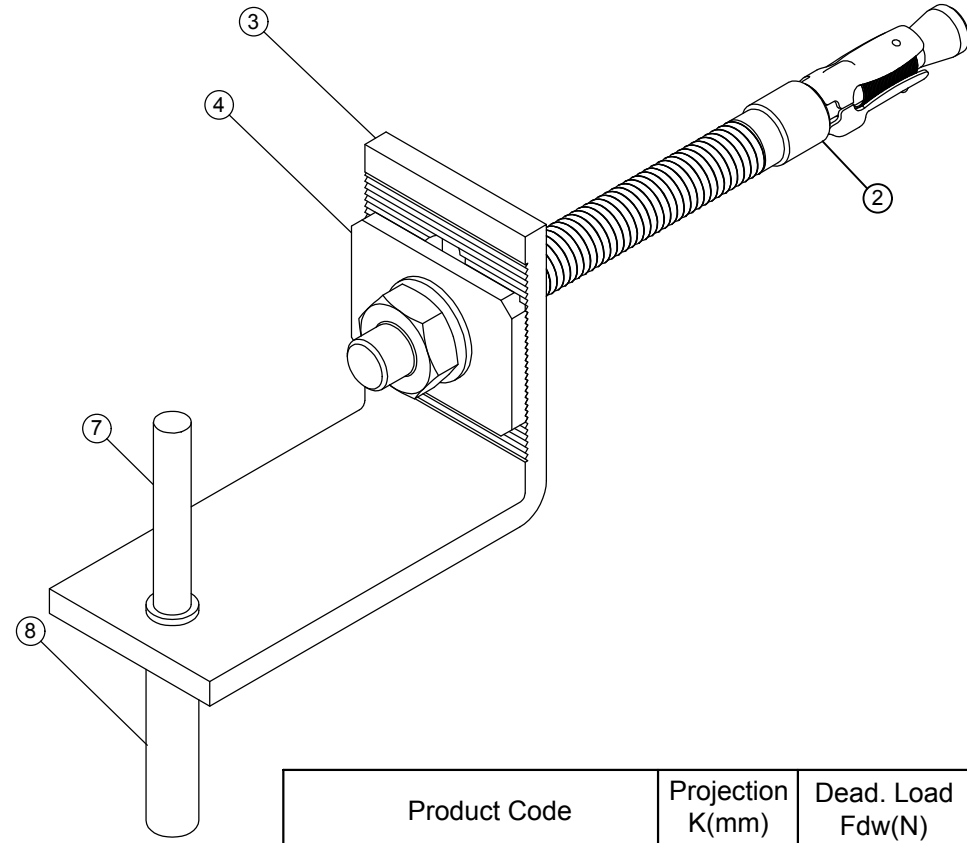

Legend	
1	Substrate
2	Anchor Bolt
3	HA01-554 Anchor Body
4	Serrated Washer
5	Stone Cladding Panel
6	Cavity
7	FLANGED PIN
8	PLASTIC TUBE

Product Code	Projection K(mm)	Dead. Load Fdw(N)	Forming Size F(mm)	Wind Load Fh(N)	Expansion Bolt Size (mm)	Anchor Thickness T Size (mm)
HA01-302	30	200	F36	219	M8X80	2.5
HA01-352	35	200	F41	219	M8X80	2.5
HA01-402	40	200	F46	219	M8X80	3
HA01-452	45	200	F57	219	M8X80	3
HA01-502	50	200	F56	219	M8X80	3
HA01-552	55	200	F61	219	M8X80	3
HA01-304	30	400	F36	437	M8X80	3
HA01-354	35	400	F41	437	M8X80	3
HA01-404	40	400	F46	437	M8X80	4
HA01-454	45	400	F57	437	M8X80	4
HA01-504	50	400	F56	437	M8X80	4
HA01-554	55	400	F61	437	M8X80	4

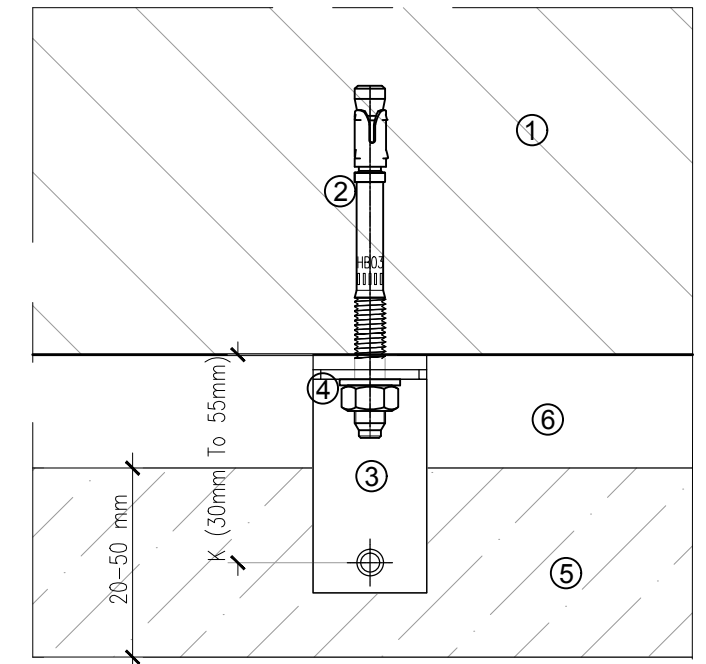

Horizontal Section Scale 1:2

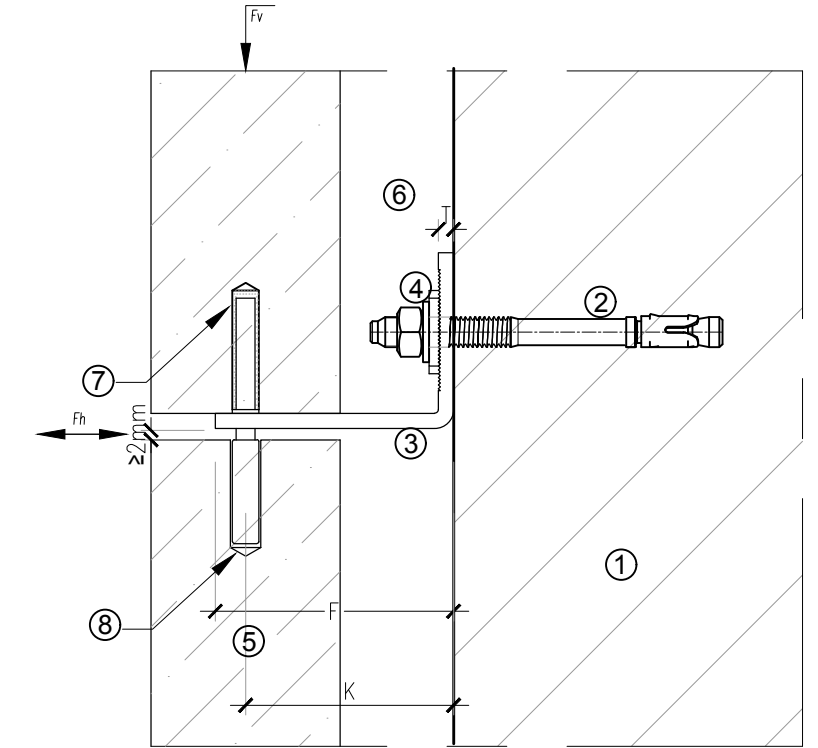

Vertical section Scale 1:2



HAZ METAL Sanayi ve Ticaret A.S
PO Box 241 31200 Iskenderun / Turkey
Tel: +90 326 6262050 Faks: 6262045
info@hazmetal.com / www.hazmetal.com.

Title : Natural Stone Facade - Built-up Cavity Wall - System HA01-554 Specification

Drawing No. HAZCD-HA01-ST-001

Series Concept Drawings - Natural Stone Fixing System - HA01-554 Support Anchors

Revision 01 scale As Shown

Page : 01/11

HA01

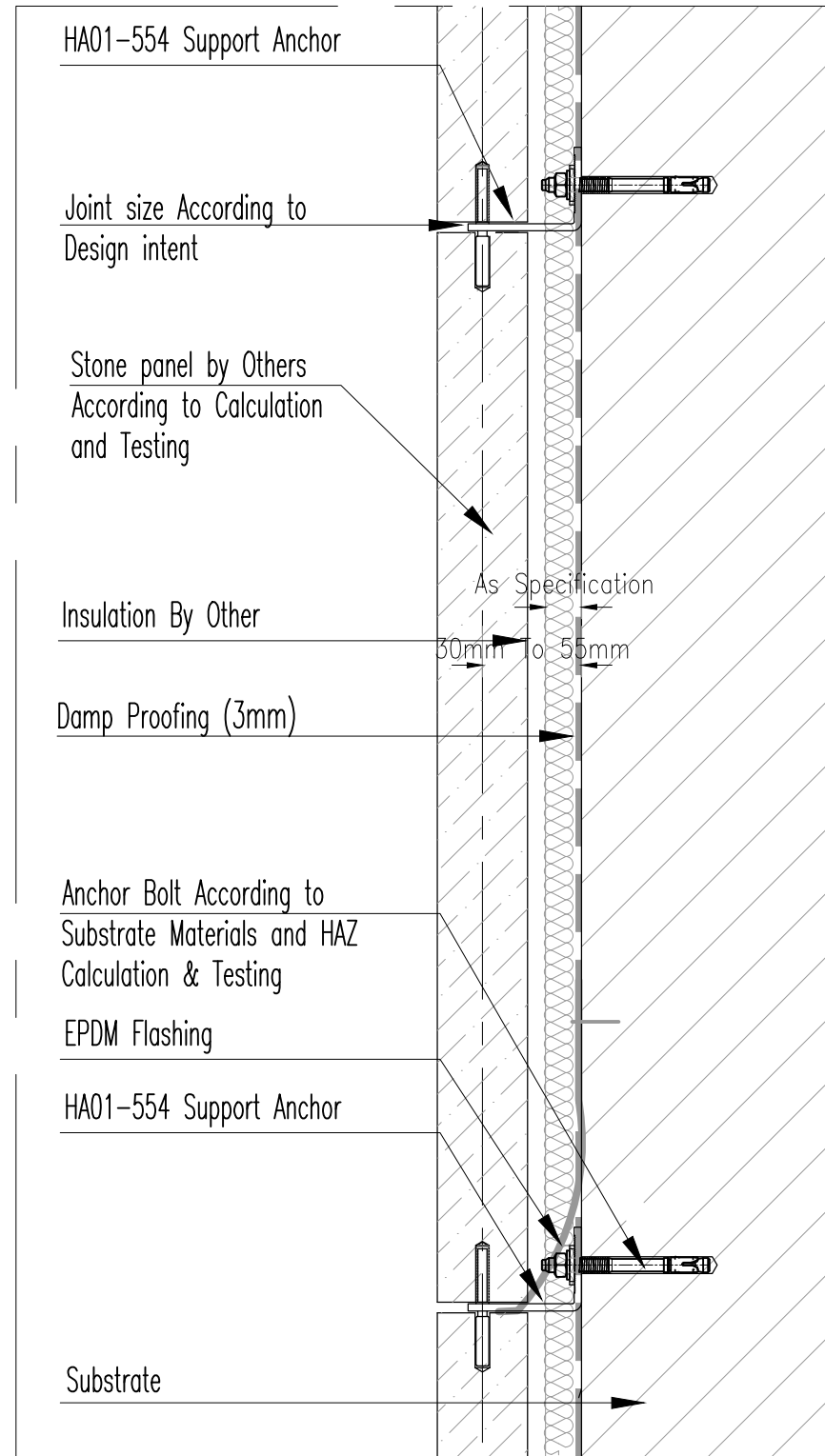

Vertical section Scale 1:4

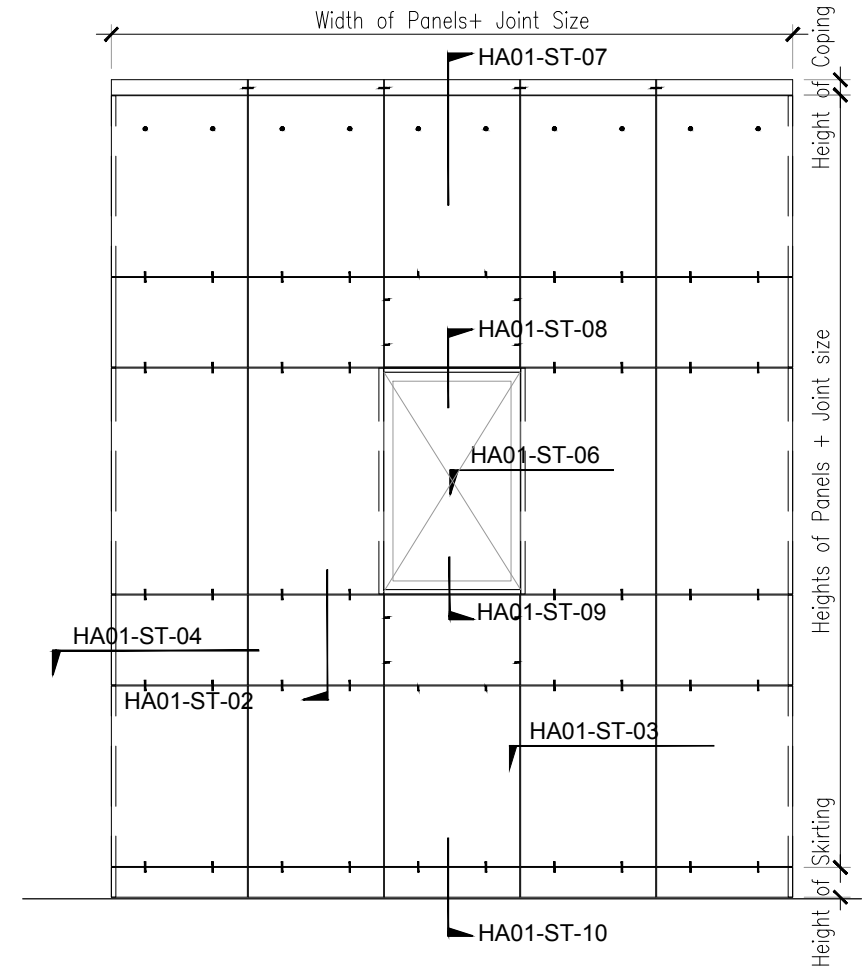

Elevation Scale 1:50



HAZ METAL Sanayi ve Ticaret A.S
 PO Box 241 31200 Iskenderun / Turkey
 Tel: +90 326 6262050 Faks: 6262045
 info@hazmetal.com / www.hazmetal.com.

Title :		Horizontal Joint Installation - Typical Stone Claddings / Rain Screen - Vertical Section		
Drawing No.	HAZCD-HA01-ST-002			
Series	Concept Drawings - Natural Stone Fixing System - HA01-554 Support Anchors			
Revision	01	scale	As Shown	Page : 02/11

HA01

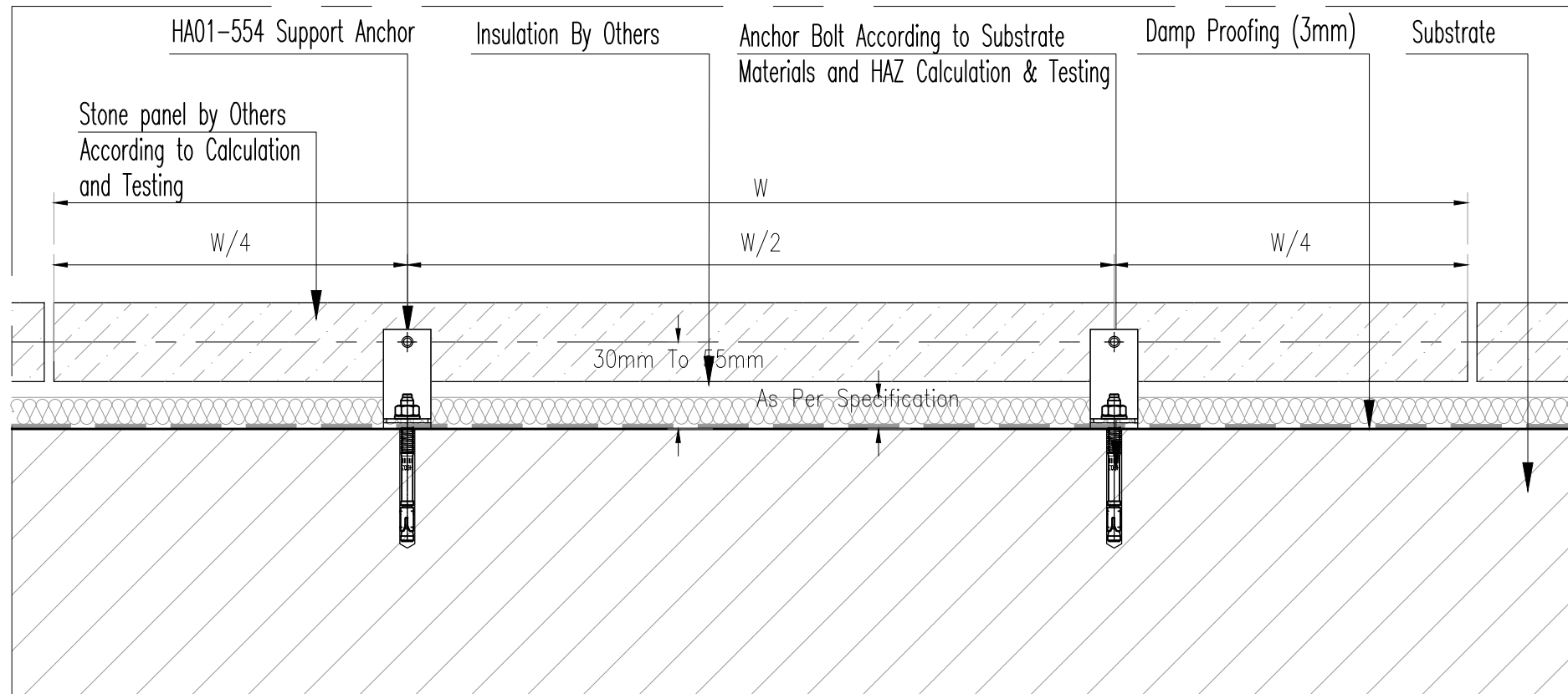

Horizontal section Scale 1:4

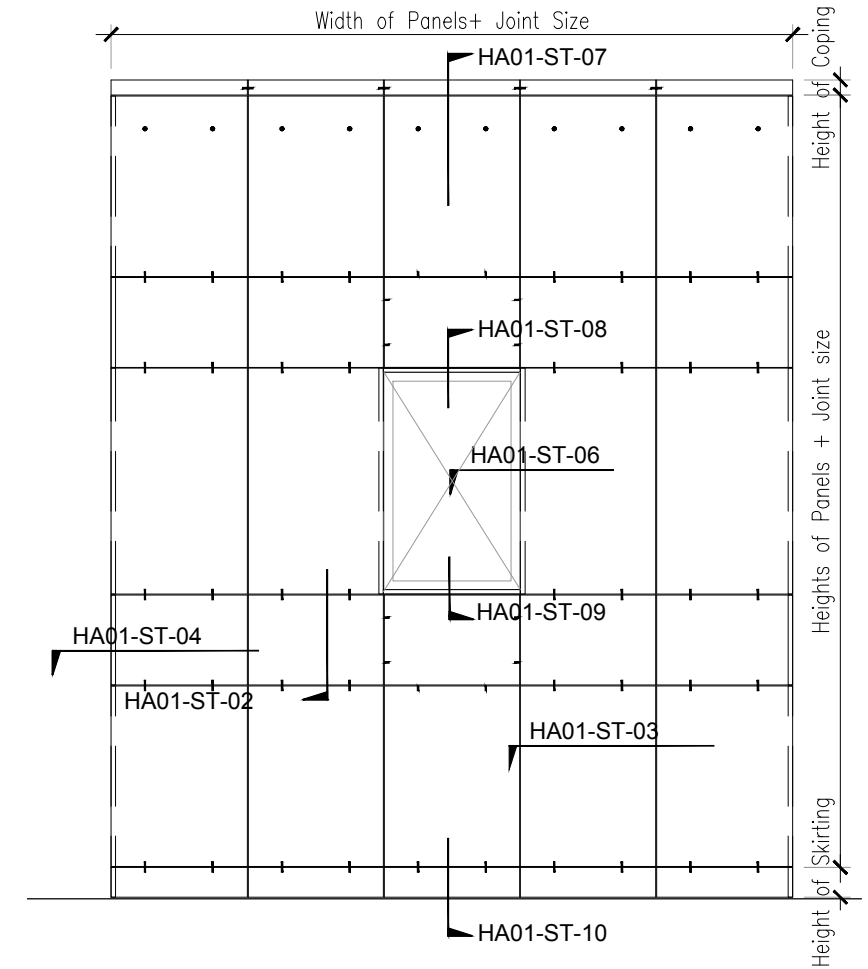

Elevation Scale 1:50



HAZ METAL Sanayi ve Ticaret A.S
 PO Box 241 31200 Iskenderun / Turkey
 Tel: +90 326 6262050 Faks: 6262045
 info@hazmetal.com / www.hazmetal.com.

Title :		Horizontal Joint Installation - Typical Stone Claddings / Rain Screen - Horizontal Section		
Drawing No.	HAZCD-HA01-ST-003			
Series	Concept Drawings - Natural Stone Fixing System - HA01-554 Support Anchors			
Revision	01	scale	As Shown	Page : 03/11

HA01

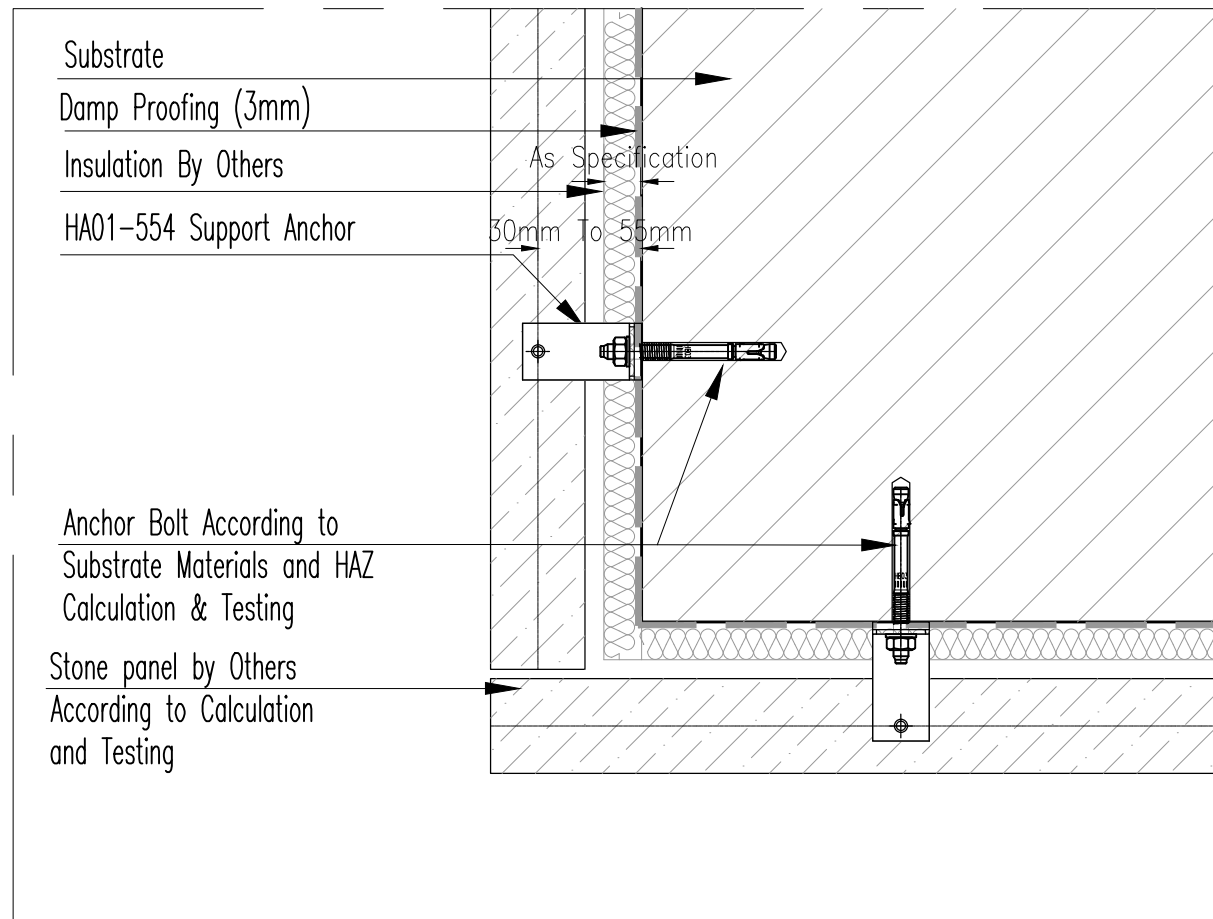

Horizontal section Scale 1:4

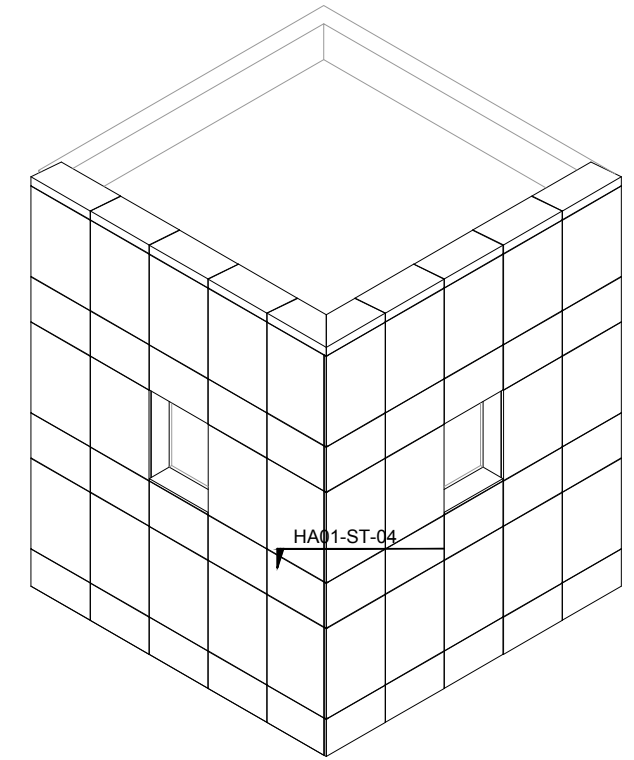

Isometric Scale 1:100



HAZ METAL Sanayi ve Ticaret A.S
 PO Box 241 31200 Iskenderun / Turkey
 Tel: +90 326 6262050 Faks: 6262045
 info@hazmetal.com / www.hazmetal.com.

Title :		Horizontal Joint Installation - External Corner Stone Cladding - Horizontal Section		
Drawing No.	HAZCD-HA01-ST-004			
Series	Concept Drawings - Natural Stone Fixing System - HA01-554 Support Anchors			
Revision	01	scale	As Shown	Page : 04/11

HA01

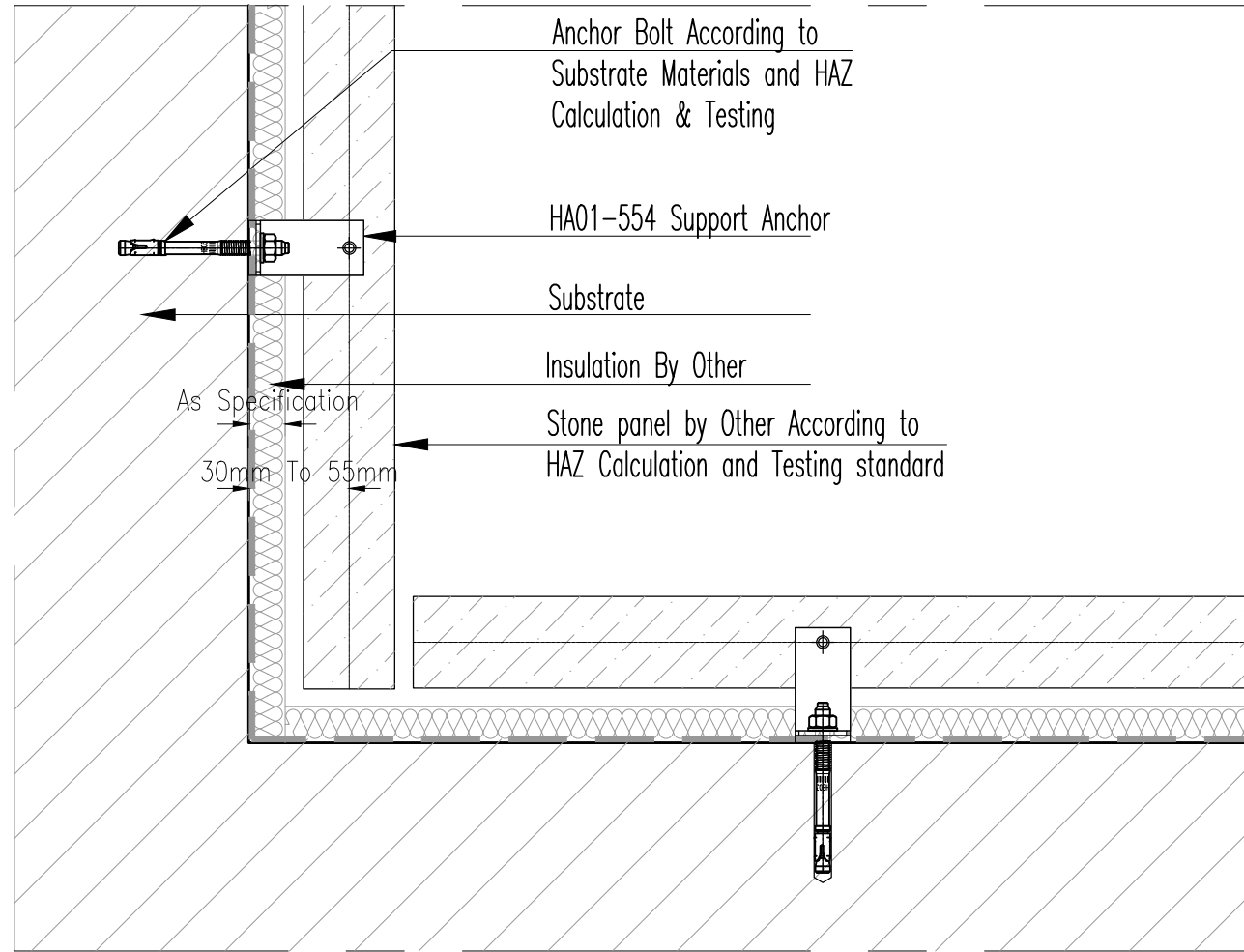

Horizontal section Scale 1:4

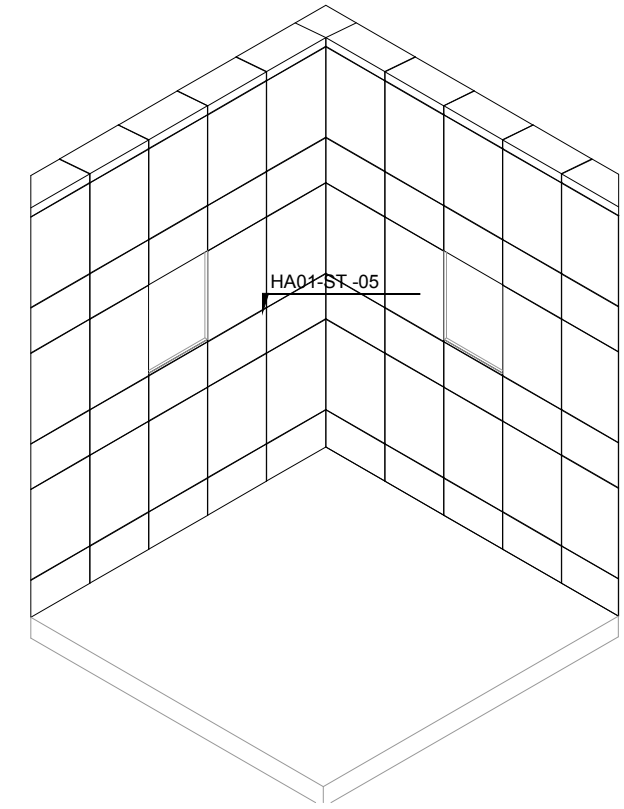

Isometric Scale 1:100



HAZ METAL Sanayi ve Ticaret A.S
 PO Box 241 31200 Iskenderun / Turkey
 Tel: +90 326 6262050 Faks: 6262045
 info@hazmetal.com / www.hazmetal.com.

Title :		Horizontal Joint Installation - Internal Corner Stone Cladding - Horizontal Section		
Drawing No.	HAZCD-HA01-ST-005			
Series	Concept Drawings - Natural Stone Fixing System - HA01-554 Support Anchors			
Revision	01	scale	As Shown	Page : 05/11

HA01

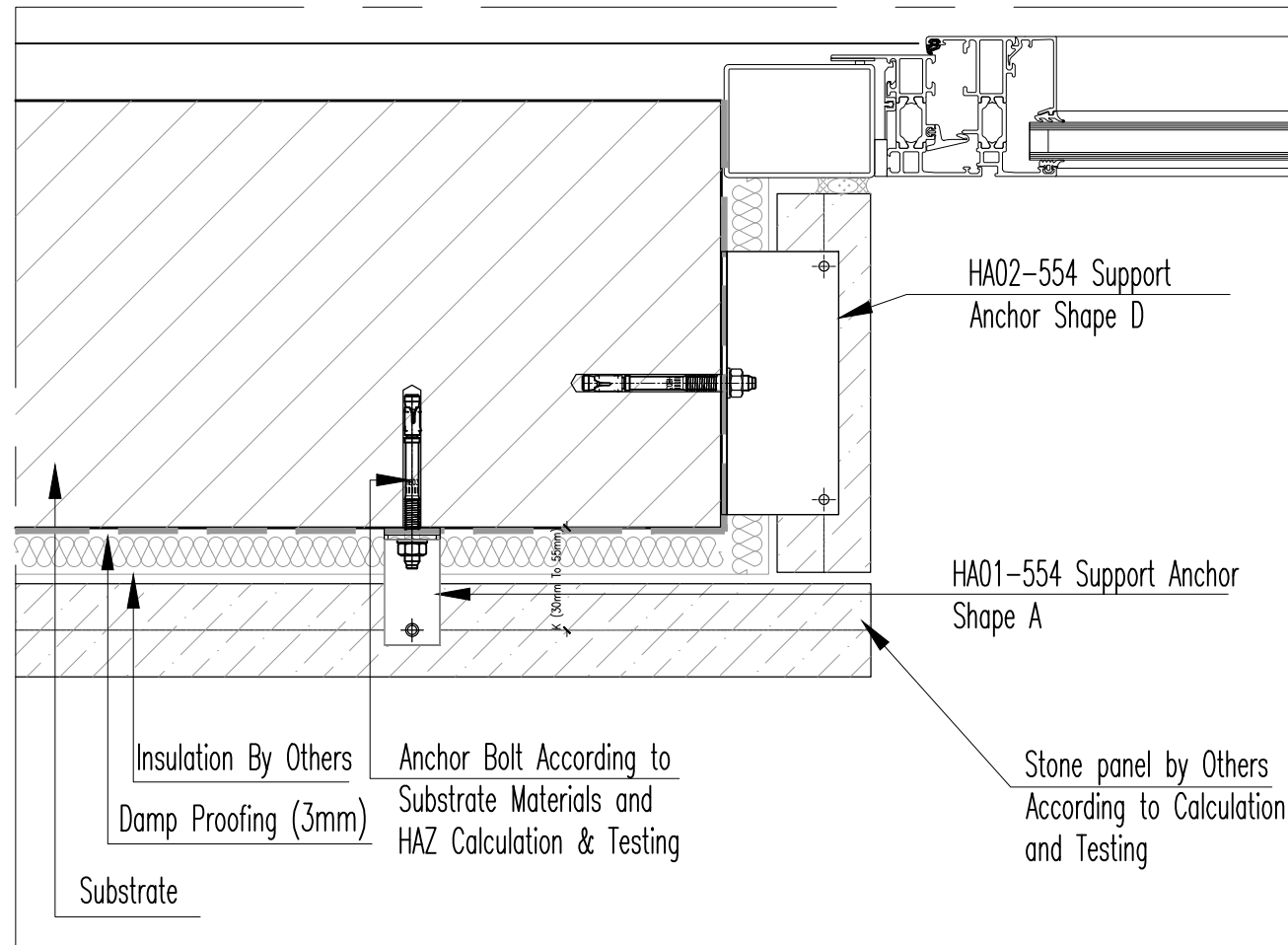

Horizontal section Scale 1:4

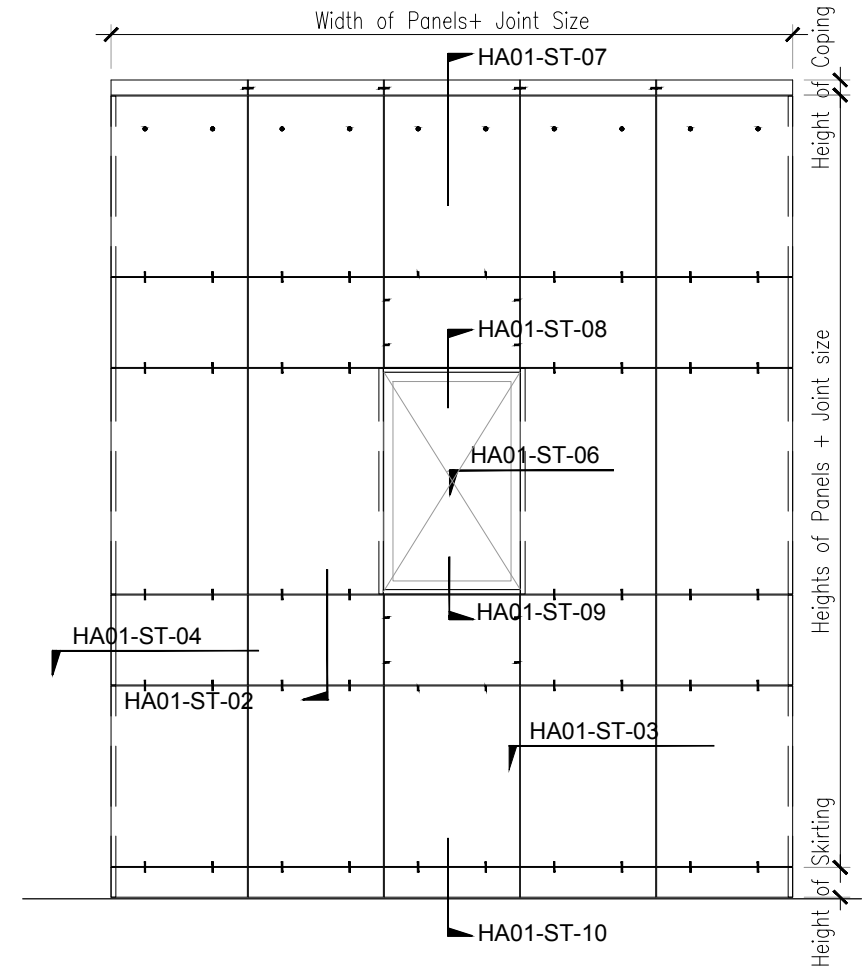

Elevation Scale 1:50



HAZ METAL Sanayi ve Ticaret A.S
 PO Box 241 31200 Iskenderun / Turkey
 Tel: +90 326 6262050 Faks: 6262045
 info@hazmetal.com / www.hazmetal.com.

Title :		Horizontal Joint Installation - Stone Reveal - Horizontal Section		
Drawing No.		HAZCD-HA01-ST-006		
Series		Concept Drawings - Natural Stone Fixing System - HA01-554 Support Anchors		
Revision		01	scale	As Shown
Page :				06/11

HA01

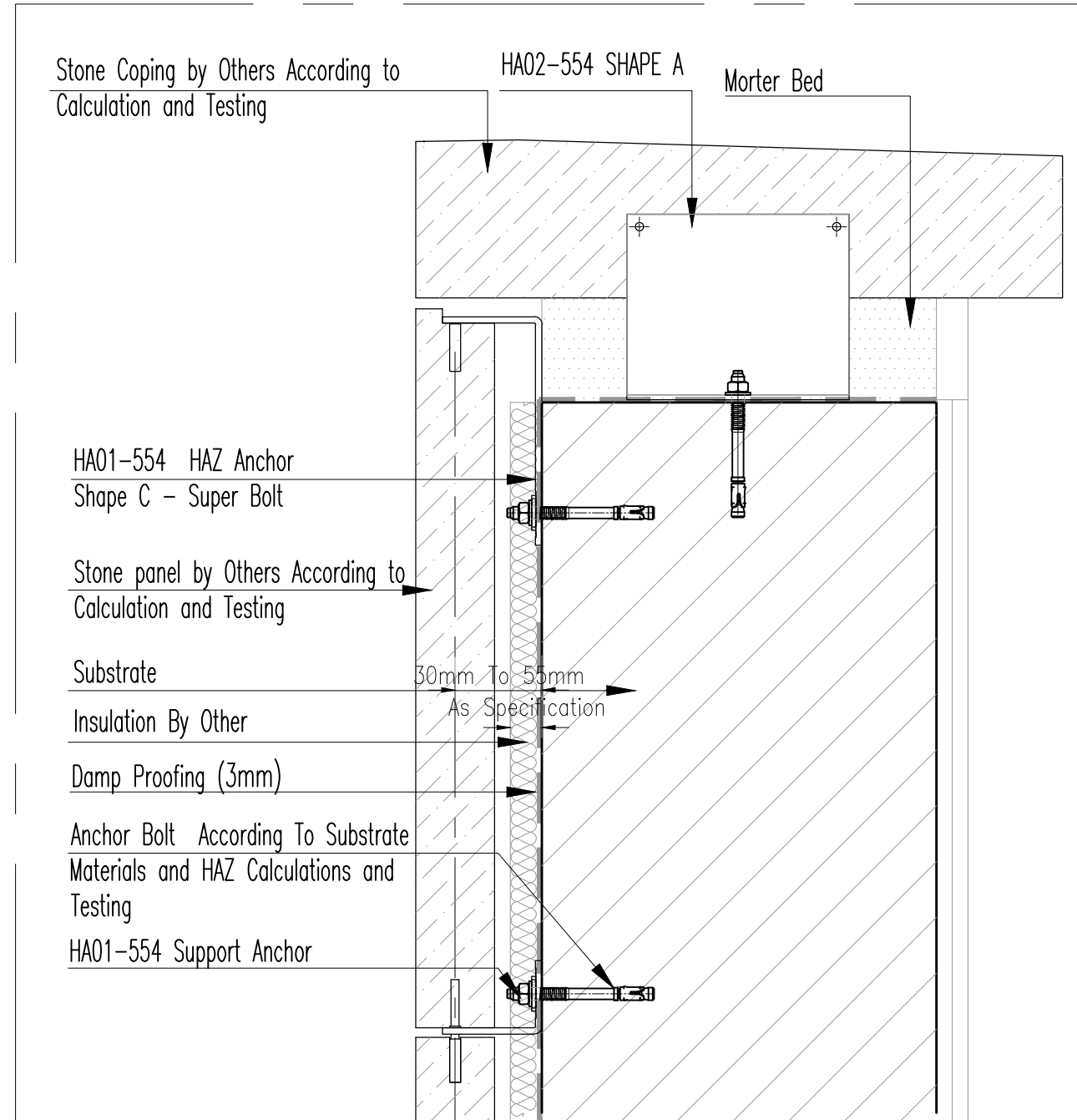

Vertical section Scale 1:4

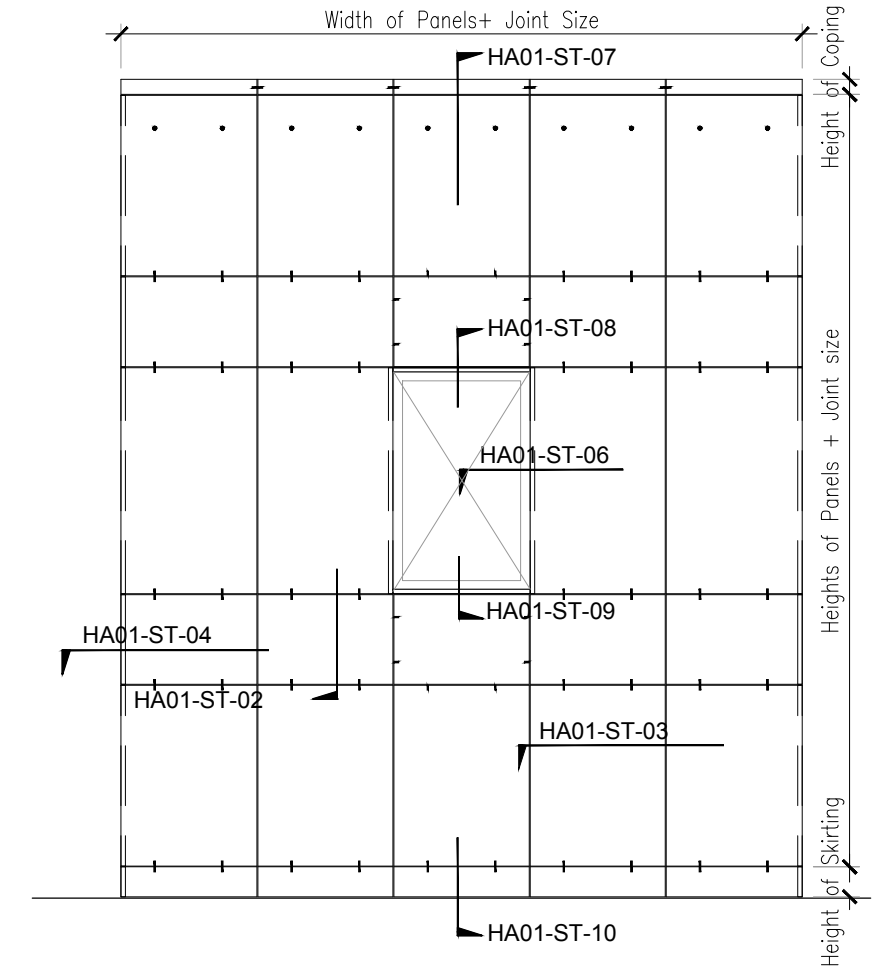

Elevation Scale 1:50



HAZ METAL Sanayi ve Ticaret A.S
 PO Box 241 31200 Iskenderun / Turkey
 Tel: +90 326 6262050 Faks: 6262045
 info@hazmetal.com / www.hazmetal.com.

Title :		Horizontal Joint Installation - Stone Coping - Vertical Section		
Drawing No.	HAZCD-HA01-ST-007			
Series	Concept Drawings - Natural Stone Fixing System - HA01-554 Support Anchors			
Revision	01	scale	As Shown	Page : 07/11

HA01

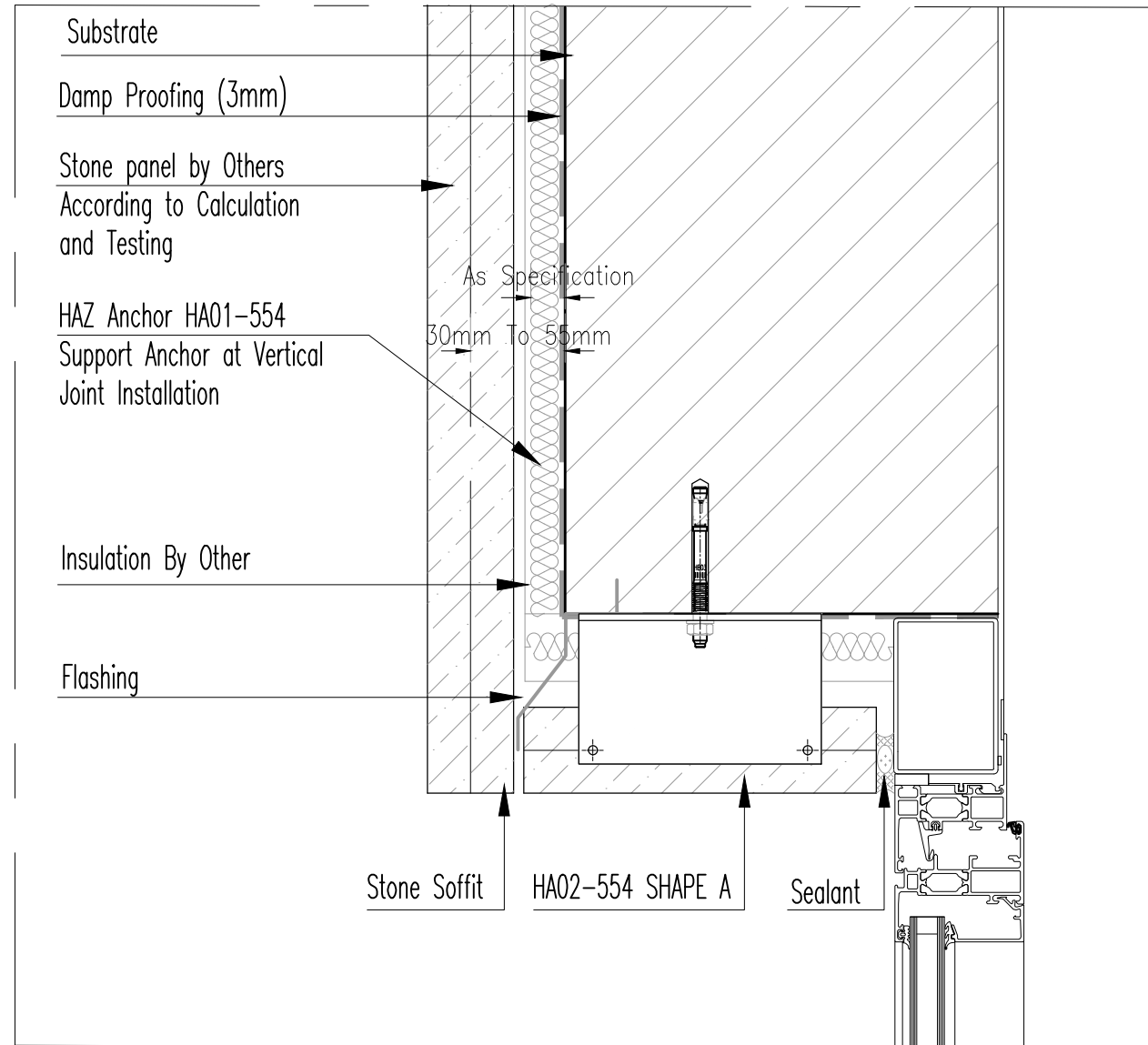

Vertical section Scale 1:4

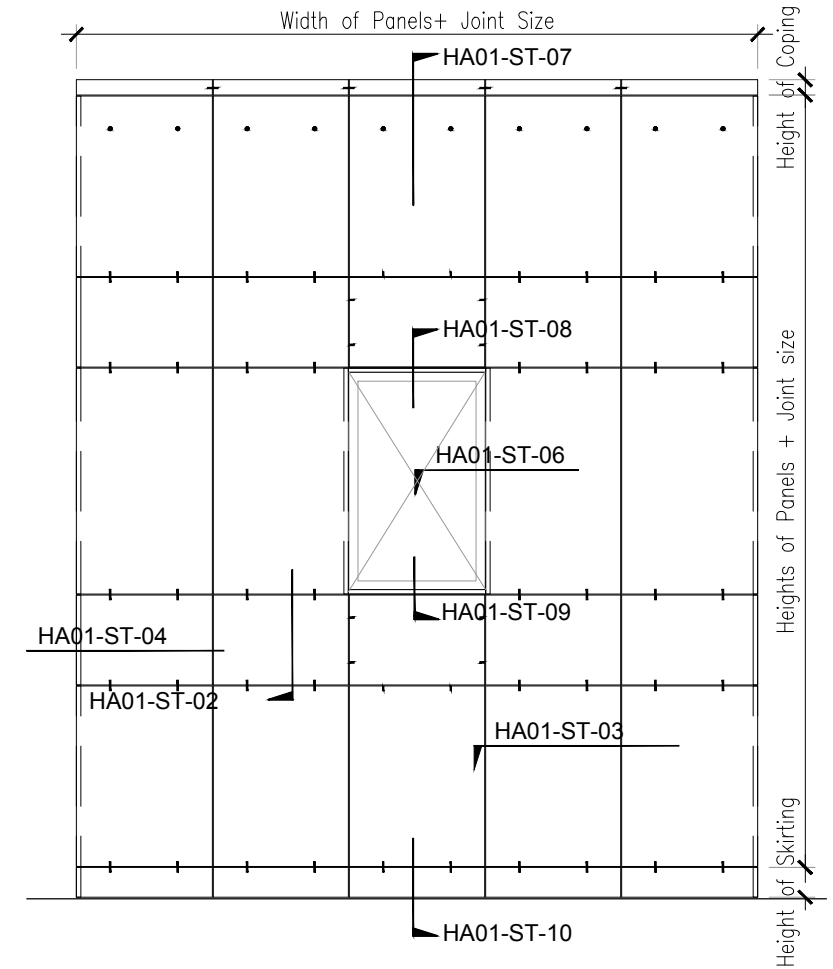

Elevation Scale 1:50



HAZ METAL Sanayi ve Ticaret A.S
 PO Box 241 31200 Iskenderun / Turkey
 Tel: +90 326 6262050 Faks: 6262045
 info@hazmetal.com / www.hazmetal.com.

Title :		Horizontal Joint Installation - Stone Soffit - Vertical Section		
Drawing No.	HAZCD-HA01-ST-008			
Series	Concept Drawings - Natural Stone Fixing System - HA01-554 Support Anchors			
Revision	01	scale	As Shown	Page : 08/11

HA01

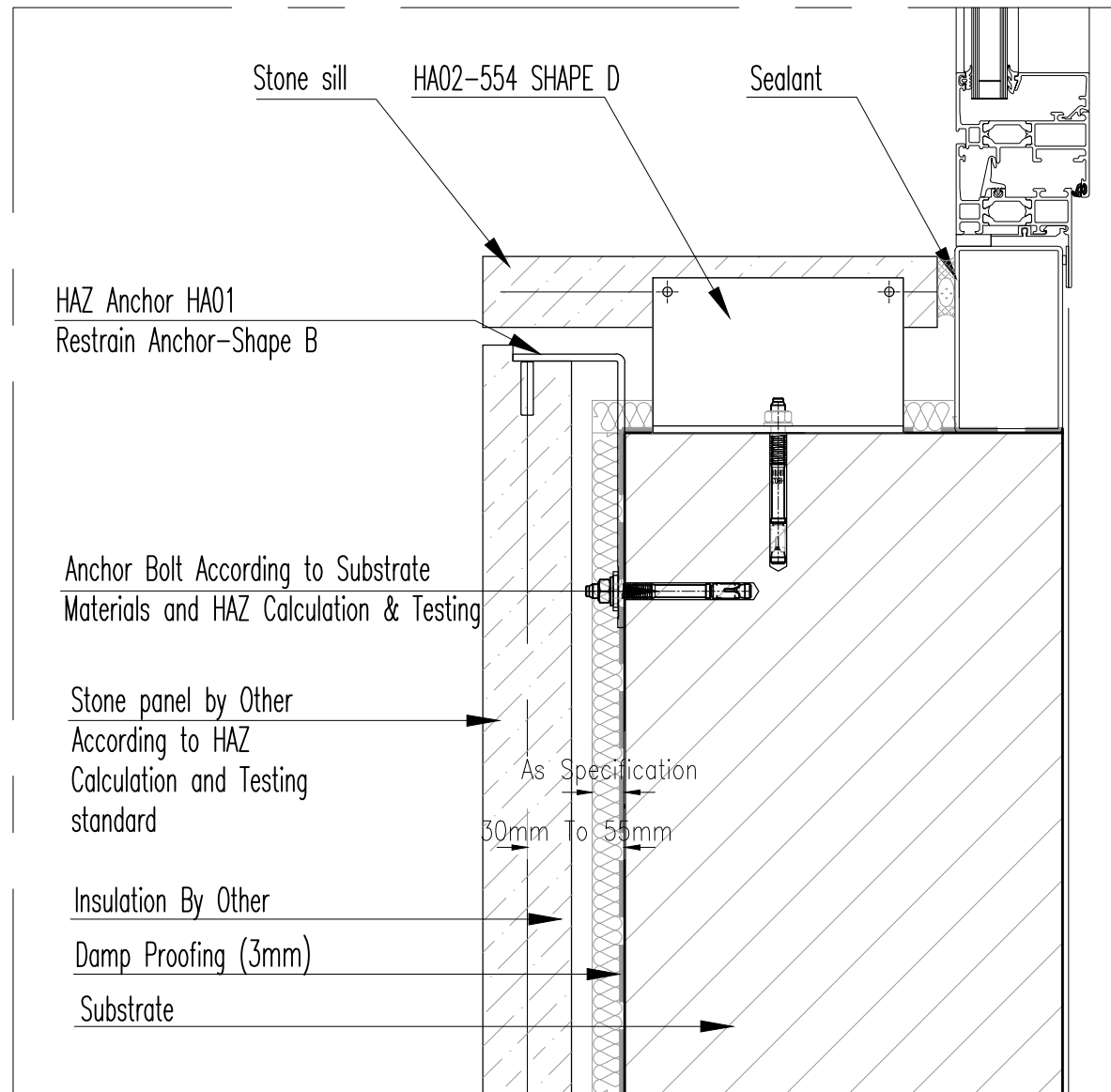

Vertical section Scale 1:4

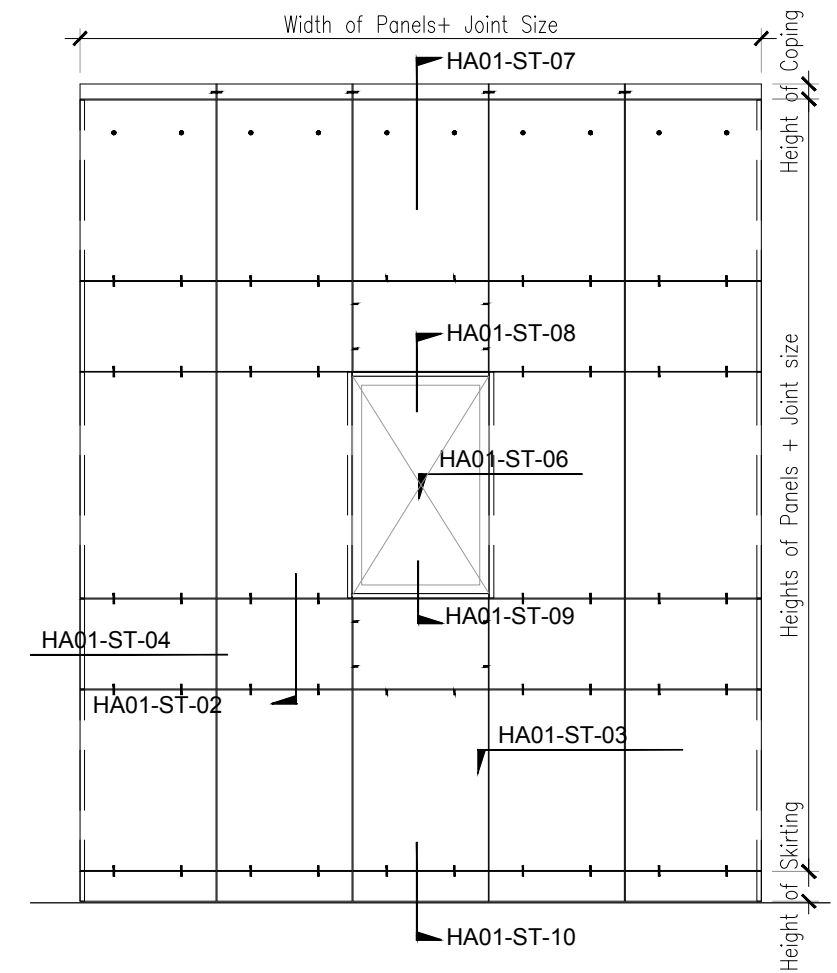

Elevation Scale 1:50



HAZ METAL Sanayi ve Ticaret A.S
 PO Box 241 31200 Iskenderun / Turkey
 Tel: +90 326 6262050 Faks: 6262045
 info@hazmetal.com / www.hazmetal.com.

Title :		Horizontal Joint Installation - Stone Sill - Vertical Section		
Drawing No.	HAZCD-HA01-ST-09			
Series	Concept Drawings - Natural Stone Fixing System - HA01-554 Support Anchors			
Revision	01	scale	As Shown	Page : 09/11

HA01

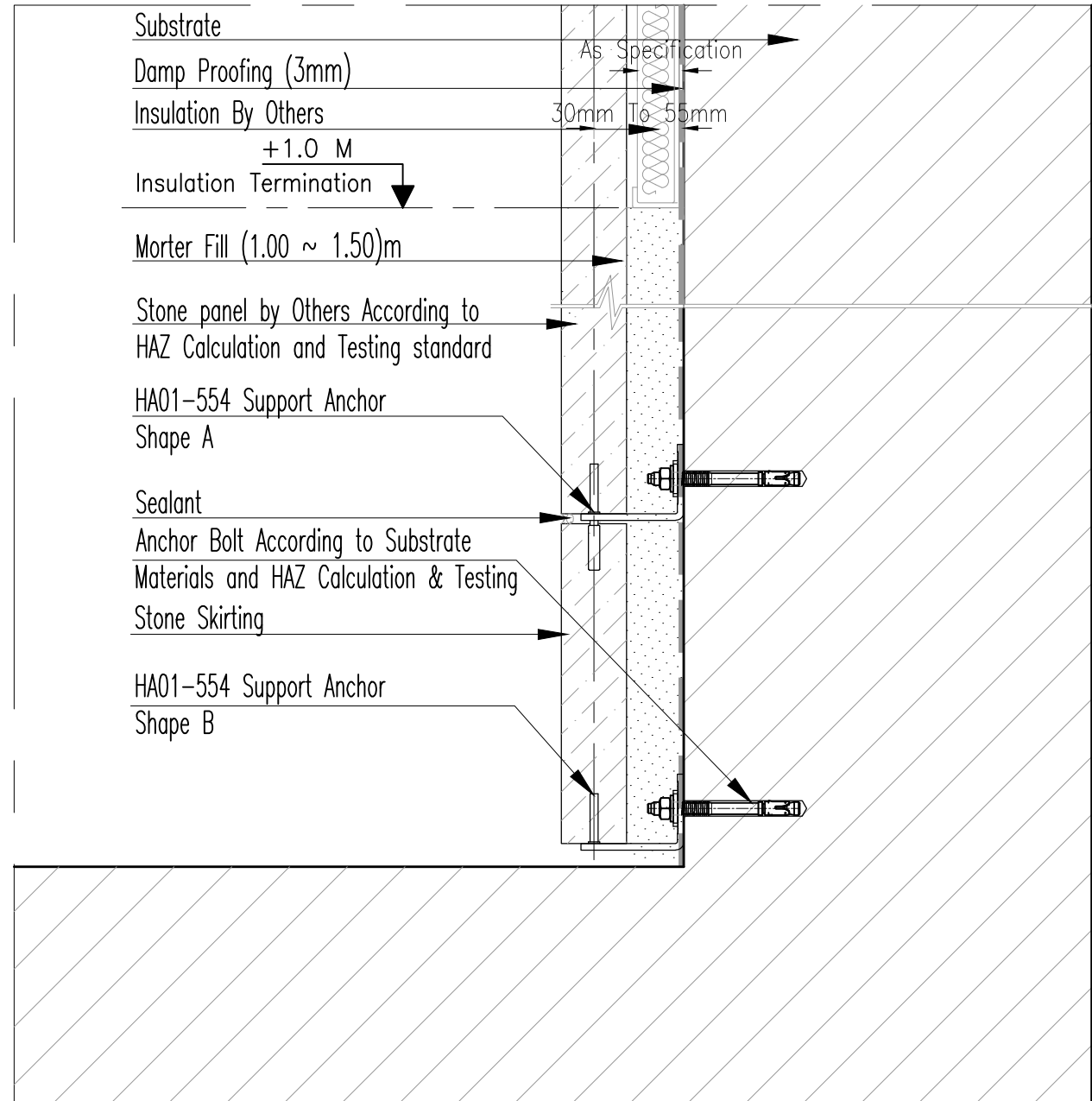

Vertical section Scale 1:4

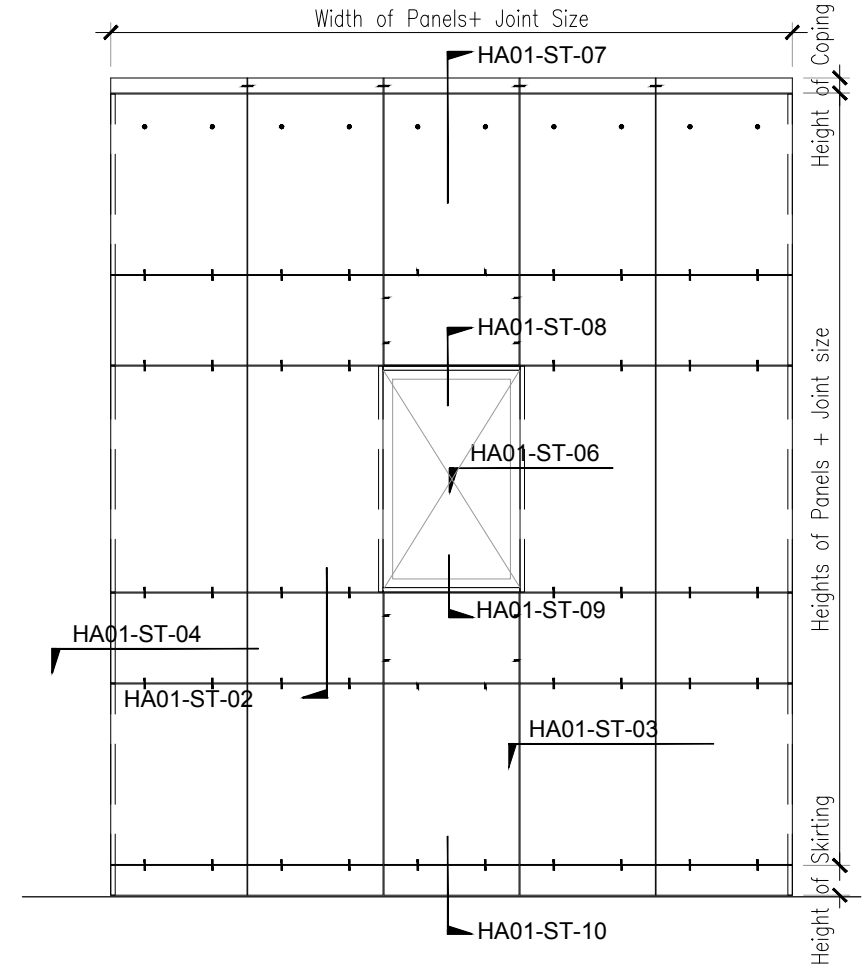

Elevation Scale 1:50



HAZ METAL Sanayi ve Ticaret A.S
 PO Box 241 31200 Iskenderun / Turkey
 Tel: +90 326 6262050 Faks: 6262045
 info@hazmetal.com / www.hazmetal.com.

Title :		Horizontal Joint Installation - Stone Skirting - Vertical Section		
Drawing No.	HAZCD-HA01-ST-10			
Series	Concept Drawings - Natural Stone Fixing System - HA01-554 Support Anchors			
Revision	01	scale	As Shown	Page : 10/11

HA01

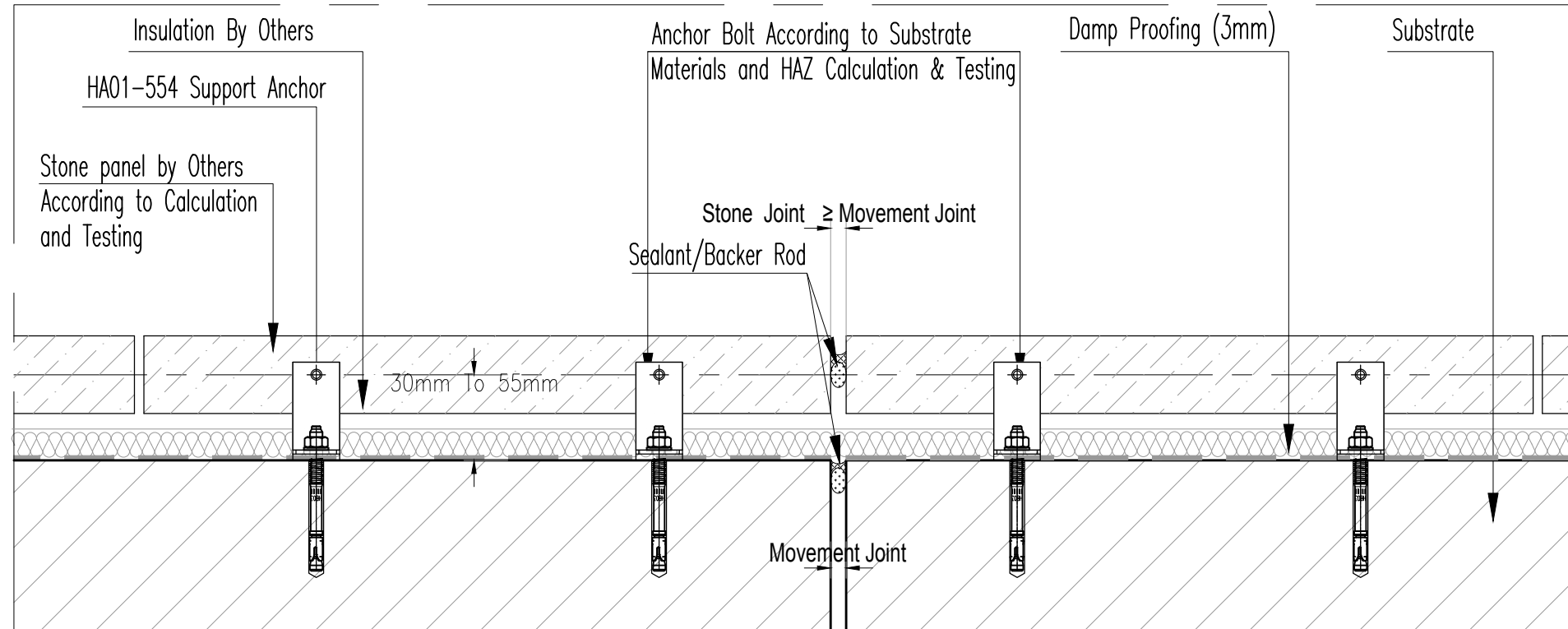

Horizontal section Scale 1:4

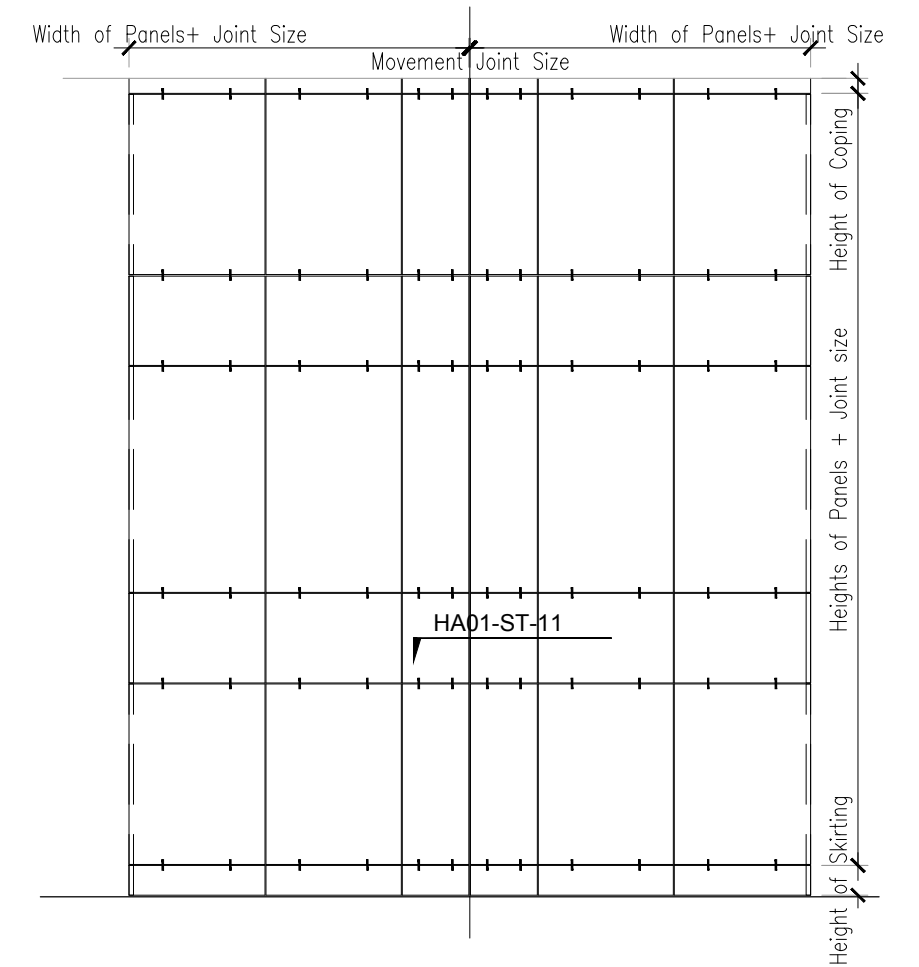

Variation on Typical Elevation
Scale 1:50



HAZ METAL Sanayi ve Ticaret A.S
PO Box 241 31200 Iskenderun / Turkey
Tel: +90 326 6262050 Faks: 6262045
info@hazmetal.com / www.hazmetal.com.

Title :		Horizontal Joint Installation - Typical Stone Claddings - Movement Joint - Horizontal Section		
Drawing No.	HAZCD-HA01-ST-11			
Series	Concept Drawings - Natural Stone Fixing System - HA01-554 Support Anchors			
Revision	01	scale	As Shown	Page : 11/11